

K-VENTIL

LINEAR GRILLES



DESCRIPTION:

Fixed single row wings, Angled wing grilles.

LM1: Linear grille with 15° angle fixed standard blades

LM2: Linear grille with 15° angle fixed slim type blades

LM3: Linear grille with 35° angle fixed type blades

MATERIAL:

Extruded Aluminum Frame and Blades

APPLICATION:

The linear grille type LM is suitable for the supply of cooled and heated air with a slight temperature difference or collecting of return air

The grille can be mounted on a wall, floor or window cill. a wide range of frames or core are available.

FINISHING:

- Standard finishing is natural anodized. Electrostatic powder coating is optional.
- Standard colors are RAL 9010 and RAL 9016. Other colors are available with enamel paint.

INSTALLATION:

- System with screws is standard.
- System with clips and plate spring is used if no hole is requested on the frame.

ACCESSORIES:

- If desired, it is possible to add a damper to adjust the amount of air to be collected.
PKD: Parallel Blade Damper
ZKD: Opposite Blade Damper
- PK: Plenum Box
- KK: Subframe
- EU2, EU3, EU4, EU5 type synthetic filter on back of grille

K-VENTIL

LINEAR GRILLES

STANDARD SIZES:

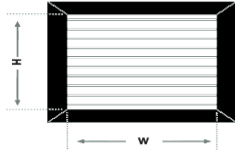

Metric System:

W : 250-300-350-400-450-500-550-600-650-700-750-800-900-1000-1100-1200-1300-1400-1500mm

H : 50-75-100-125-150-175-200-225-250-300-400-500-600mm

* Any combination of these sizes

Inc. System:

AVAILABLE SIZES (in.) - Always width x height											
HEIGHT	WIDHT										
	4	6	8	10	12	14	16	18	20	22	24
2	X	X	X	X	X	X	X	X	X	X	X
3	X	X	X	X	X	X	X	X	X	X	X
4	X	X	X	X	X	X	X	X	X	X	X
5	X	X	X	X	X	X	X	X	X	X	X
6	X	X	X	X	X	X	X	X	X	X	X
7	X	X	X	X	X	X	X	X	X	X	X
8	X	X	X	X	X	X	X	X	X	X	X
10	X	X	X	X	X	X	X	X	X	X	X
12	X	X	X	X	X	X	X	X	X	X	X
14	X	X	X	X	X	X	X	X	X	X	X
16	X	X	X	X	X	X	X	X	X	X	X
18	X	X	X	X	X	X	X	X	X	X	X
20	X	X	X	X	X	X	X	X	X	X	X
22	X	X	X	X	X	X	X	X	X	X	X
24	X	X	X	X	X	X	X	X	X	X	X

* Any combination of these sizes

FRAME TYPES:

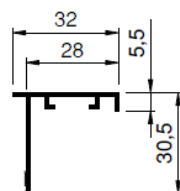
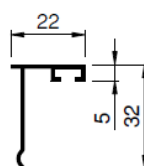
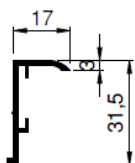

K-VENTIL

LINEAR GRILLES

17mm frame

22mm frame

32mm frame

LM LINEAR GRILLE TYPES WITH FRAME:

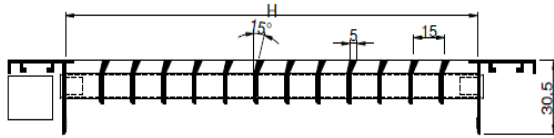

LM1 standard blade type

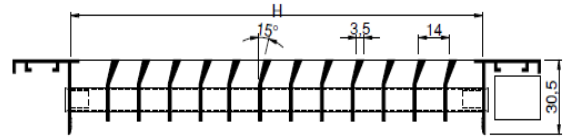

LM2 slim blade type

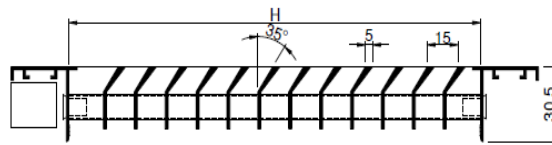

LM3 angle blade type

LM LINEAR GRILLE TYPES WITHOUT FRAME :

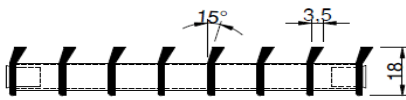

LM-1

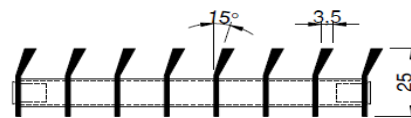

LM-2

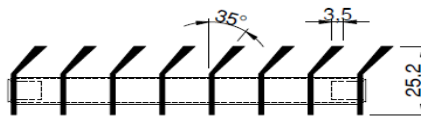

LM-3

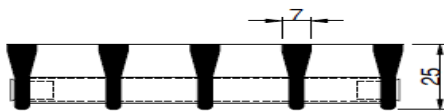

LM-Y1

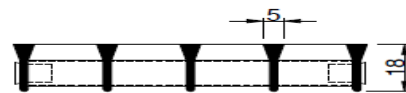

LM-Y2

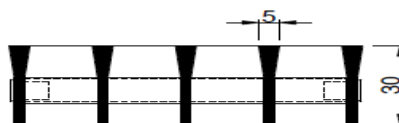

LM-Y3

K-VENTIL

LINEAR GRILLES

FLOOR LINEAR GRILLE WITH MOUNTING FRAME:

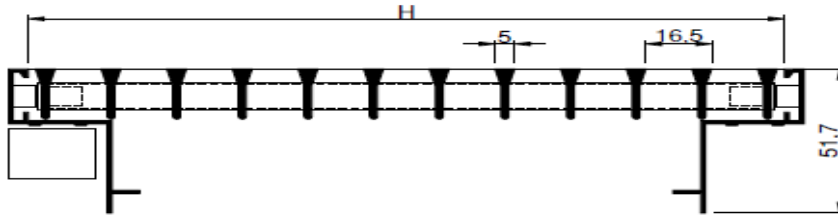

CORNER LINEAR GRILLE TYPES:

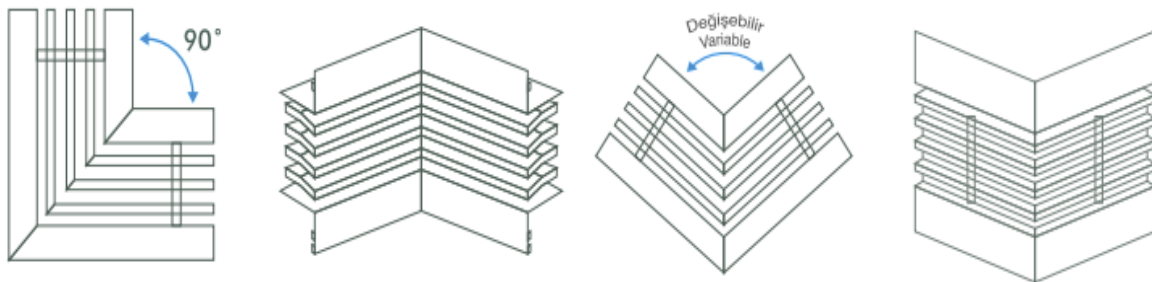

LM1 LINEAR GRILLES SELECTION TABLE - 1

Neck Size WxH mm x mm	Effective Area m ²	AIR VELOCITY m/s															
		1,5 m/s		2,0 m/s		2,5 m/s		3,0 m/s		4,0 m/s		5,0 m/s		6,0 m/s		7,0 m/s	
200x75	0,010	54,00	m ³ /h	72,00	m ³ /h	90,00	m ³ /h	108,00	m ³ /h	144,00	m ³ /h	180,00	m ³ /h	216,00	m ³ /h	252,00	m ³ /h
250x75	0,013	70,20	m ³ /h	93,60	m ³ /h	117,00	m ³ /h	140,40	m ³ /h	187,20	m ³ /h	234,00	m ³ /h	280,80	m ³ /h	327,60	m ³ /h
300x75	0,015	81,00	m ³ /h	108,00	m ³ /h	135,00	m ³ /h	162,00	m ³ /h	216,00	m ³ /h	270,00	m ³ /h	324,00	m ³ /h	378,00	m ³ /h
400x75	0,020	108,00	m ³ /h	144,00	m ³ /h	180,00	m ³ /h	216,00	m ³ /h	288,00	m ³ /h	360,00	m ³ /h	432,00	m ³ /h	504,00	m ³ /h
450x75	0,023	124,20	m ³ /h	165,60	m ³ /h	207,00	m ³ /h	248,40	m ³ /h	331,20	m ³ /h	414,00	m ³ /h	496,80	m ³ /h	579,60	m ³ /h
500x75	0,025	135,00	m ³ /h	180,00	m ³ /h	225,00	m ³ /h	270,00	m ³ /h	360,00	m ³ /h	450,00	m ³ /h	540,00	m ³ /h	630,00	m ³ /h
600x75	0,030	162,00	m ³ /h	216,00	m ³ /h	270,00	m ³ /h	324,00	m ³ /h	432,00	m ³ /h	540,00	m ³ /h	648,00	m ³ /h	756,00	m ³ /h
700x75	0,035	189,00	m ³ /h	252,00	m ³ /h	315,00	m ³ /h	378,00	m ³ /h	504,00	m ³ /h	630,00	m ³ /h	756,00	m ³ /h	882,00	m ³ /h
800x75	0,040	216,00	m ³ /h	288,00	m ³ /h	360,00	m ³ /h	432,00	m ³ /h	576,00	m ³ /h	720,00	m ³ /h	864,00	m ³ /h	1008,00	m ³ /h
1000x75	0,050	270,00	m ³ /h	360,00	m ³ /h	450,00	m ³ /h	540,00	m ³ /h	720,00	m ³ /h	900,00	m ³ /h	1080,00	m ³ /h	1260,00	m ³ /h
200x100	0,013	70,20	m ³ /h	93,60	m ³ /h	117,00	m ³ /h	140,40	m ³ /h	187,20	m ³ /h	234,00	m ³ /h	280,80	m ³ /h	327,60	m ³ /h
250x100	0,017	91,80	m ³ /h	122,40	m ³ /h	153,00	m ³ /h	183,60	m ³ /h	244,80	m ³ /h	306,00	m ³ /h	367,20	m ³ /h	428,40	m ³ /h
300x100	0,020	108,00	m ³ /h	144,00	m ³ /h	180,00	m ³ /h	216,00	m ³ /h	288,00	m ³ /h	360,00	m ³ /h	432,00	m ³ /h	504,00	m ³ /h
400x100	0,027	145,80	m ³ /h	194,40	m ³ /h	243,00	m ³ /h	291,60	m ³ /h	388,80	m ³ /h	486,00	m ³ /h	583,20	m ³ /h	680,40	m ³ /h
450x100	0,030	162,00	m ³ /h	216,00	m ³ /h	270,00	m ³ /h	324,00	m ³ /h	432,00	m ³ /h	540,00	m ³ /h	648,00	m ³ /h	756,00	m ³ /h
500x100	0,033	178,20	m ³ /h	237,60	m ³ /h	297,00	m ³ /h	356,40	m ³ /h	475,20	m ³ /h	594,00	m ³ /h	712,80	m ³ /h	831,60	m ³ /h
600x100	0,040	216,00	m ³ /h	288,00	m ³ /h	360,00	m ³ /h	432,00	m ³ /h	576,00	m ³ /h	720,00	m ³ /h	864,00	m ³ /h	1008,00	m ³ /h
700x100	0,047	253,80	m ³ /h	338,40	m ³ /h	423,00	m ³ /h	507,60	m ³ /h	676,80	m ³ /h	846,00	m ³ /h	1015,20	m ³ /h	1184,40	m ³ /h
800x100	0,053	286,20	m ³ /h	381,60	m ³ /h	477,00	m ³ /h	572,40	m ³ /h	763,20	m ³ /h	954,00	m ³ /h	1144,80	m ³ /h	1335,60	m ³ /h
1000x100	0,067	361,80	m ³ /h	482,40	m ³ /h	603,00	m ³ /h	723,60	m ³ /h	964,80	m ³ /h	1206,00	m ³ /h	1447,20	m ³ /h	1688,40	m ³ /h
200x150	0,020	108,00	m ³ /h	144,00	m ³ /h	180,00	m ³ /h	216,00	m ³ /h	288,00	m ³ /h	360,00	m ³ /h	432,00	m ³ /h	504,00	m ³ /h
250x150	0,025	135,00	m ³ /h	180,00	m ³ /h	225,00	m ³ /h	270,00	m ³ /h	360,00	m ³ /h	450,00	m ³ /h	540,00	m ³ /h	630,00	m ³ /h
300x150	0,030	162,00	m ³ /h	216,00	m ³ /h	270,00	m ³ /h	324,00	m ³ /h	432,00	m ³ /h	540,00	m ³ /h	648,00	m ³ /h	756,00	m ³ /h
400x150	0,040	216,00	m ³ /h	288,00	m ³ /h	360,00	m ³ /h	432,00	m ³ /h	576,00	m ³ /h	720,00	m ³ /h	864,00	m ³ /h	1008,00	m ³ /h
450x150	0,045	243,00	m ³ /h	324,00	m ³ /h	405,00	m ³ /h	486,00	m ³ /h	648,00	m ³ /h	810,00	m ³ /h	972,00	m ³ /h	1134,00	m ³ /h
500x150	0,050	270,00	m ³ /h	360,00	m ³ /h	450,00	m ³ /h	540,00	m ³ /h	720,00	m ³ /h	900,00	m ³ /h	1080,00	m ³ /h	1260,00	m ³ /h
600x150	0,060	324,00	m ³ /h	432,00	m ³ /h	540,00	m ³ /h	648,00	m ³ /h	864,00	m ³ /h	1080,00	m ³ /h	1296,00	m ³ /h	1512,00	m ³ /h
700x150	0,070	378,00	m ³ /h	504,00	m ³ /h	630,00	m ³ /h	756,00	m ³ /h	1008,00	m ³ /h	1260,00	m ³ /h	1512,00	m ³ /h	1764,00	m ³ /h
800x150	0,080	432,00	m ³ /h	576,00	m ³ /h	720,00	m ³ /h	864,00	m ³ /h	1152,00	m ³ /h	1440,00	m ³ /h	1728,00	m ³ /h	2016,00	m ³ /h
1000x150	0,100	540,00	m ³ /h	720,00	m ³ /h	900,00	m ³ /h	1080,00	m ³ /h	1440,00	m ³ /h	1800,00	m ³ /h	2160,00	m ³ /h	2520,00	m ³ /h
200x200	0,027	145,80	m ³ /h	194,40	m ³ /h	243,00	m ³ /h	291,60	m ³ /h	388,80	m ³ /h	486,00	m ³ /h	583,20	m ³ /h	680,40	m ³ /h
250x200	0,033	178,20	m ³ /h	237,60	m ³ /h	297,00	m ³ /h	356,40	m ³ /h	475,20	m ³ /h	594,00	m ³ /h	712,80	m ³ /h	831,60	m ³ /h
300x200	0,040	216,00	m ³ /h	288,00	m ³ /h	360,00	m ³ /h	432,00	m ³ /h	576,00	m ³ /h	720,00	m ³ /h	864,00	m ³ /h	1008,00	m ³ /h
400x200	0,053	286,20	m ³ /h	381,60	m ³ /h	477,00	m ³ /h	572,40	m ³ /h	763,20	m ³ /h	954,00	m ³ /h	1144,80	m ³ /h	1335,60	m ³ /h
450x200	0,060	324,00	m ³ /h	432,00	m ³ /h	540,00	m ³ /h	648,00	m ³ /h	864,00	m ³ /h	1080,00	m ³ /h	1296,00	m ³ /h	1512,00	m ³ /h
500x200	0,067	361,80	m ³ /h	482,40	m ³ /h	603,00	m ³ /h	723,60	m ³ /h	964,80	m ³ /h	1206,00	m ³ /h	1447,20	m ³ /h	1688,40	m ³ /h
600x200	0,080	432,00	m ³ /h	576,00	m ³ /h	720,00	m ³ /h	864,00	m ³ /h	1152,00	m ³ /h	1440,00	m ³ /h	1728,00	m ³ /h	2016,00	m ³ /h
700x200	0,093	502,20	m ³ /h	669,60	m ³ /h	837,00	m ³ /h	1004,40	m ³ /h	1339,20	m ³ /h	1674,00	m ³ /h	2008,80	m ³ /h	2343,60	m ³ /h
800x200	0,107	577,80	m ³ /h	770,40	m ³ /h	963,00	m ³ /h	1155,60	m ³ /h	1540,80	m ³ /h	1926,00	m ³ /h	2311,20	m ³ /h	2696,40	m ³ /h
1000x200	0,133	718,20	m ³ /h	957,60	m ³ /h	1197,00	m ³ /h	1436,40	m ³ /h	1915,20	m ³ /h	2394,00	m ³ /h	2872,80	m ³ /h	3351,60	m ³ /h
1000x250	0,167	901,80	m ³ /h	1202,40	m ³ /h	1503,00	m ³ /h	1803,60	m ³ /h	2404,80	m ³ /h	3006,00	m ³ /h	3607,20	m ³ /h	4208,40	m ³ /h
1000x300	0,200	1080,00	m ³ /h	1440,00	m ³ /h	1800,00	m ³ /h	2160,00	m ³ /h	2880,00	m ³ /h	3600,00	m ³ /h	4320,00	m ³ /h	5040,00	m ³ /h
1000x400	0,267	1441,80	m ³ /h	1922,40	m ³ /h	2403,00	m ³ /h	2883,60	m ³ /h	3844,80	m ³ /h	4806,00	m ³ /h	5767,20	m ³ /h	6728,40	m ³ /h

LM2 - LM3 LINEAR GRILLES SELECTION TABLE - 2

Neck Size WxH mm x mm	Effective Area m ²	AIR VELOCITY m/s															
		1,5 m/s		2,0 m/s		2,5 m/s		3,0 m/s		4,0 m/s		5,0 m/s		6,0 m/s		7,0 m/s	
200x75	0,012	64,80	m ³ /h	86,40	m ³ /h	108,00	m ³ /h	129,60	m ³ /h	172,80	m ³ /h	216,00	m ³ /h	259,20	m ³ /h	302,40	m ³ /h
250x75	0,014	75,60	m ³ /h	100,80	m ³ /h	126,00	m ³ /h	151,20	m ³ /h	201,60	m ³ /h	252,00	m ³ /h	302,40	m ³ /h	352,80	m ³ /h
300x75	0,017	91,80	m ³ /h	122,40	m ³ /h	153,00	m ³ /h	183,60	m ³ /h	244,80	m ³ /h	306,00	m ³ /h	367,20	m ³ /h	428,40	m ³ /h
400x75	0,023	124,20	m ³ /h	165,60	m ³ /h	207,00	m ³ /h	248,40	m ³ /h	331,20	m ³ /h	414,00	m ³ /h	496,80	m ³ /h	579,60	m ³ /h
450x75	0,026	140,40	m ³ /h	187,20	m ³ /h	234,00	m ³ /h	280,80	m ³ /h	374,40	m ³ /h	468,00	m ³ /h	561,60	m ³ /h	655,20	m ³ /h
500x75	0,029	156,60	m ³ /h	208,80	m ³ /h	261,00	m ³ /h	313,20	m ³ /h	417,60	m ³ /h	522,00	m ³ /h	626,40	m ³ /h	730,80	m ³ /h
600x75	0,035	189,00	m ³ /h	252,00	m ³ /h	315,00	m ³ /h	378,00	m ³ /h	504,00	m ³ /h	630,00	m ³ /h	756,00	m ³ /h	882,00	m ³ /h
700x75	0,040	216,00	m ³ /h	288,00	m ³ /h	360,00	m ³ /h	432,00	m ³ /h	576,00	m ³ /h	720,00	m ³ /h	864,00	m ³ /h	1008,00	m ³ /h
800x75	0,046	248,40	m ³ /h	331,20	m ³ /h	414,00	m ³ /h	496,80	m ³ /h	662,40	m ³ /h	828,00	m ³ /h	993,60	m ³ /h	1159,20	m ³ /h
1000x75	0,058	313,20	m ³ /h	417,60	m ³ /h	522,00	m ³ /h	626,40	m ³ /h	835,20	m ³ /h	1044,00	m ³ /h	1252,80	m ³ /h	1461,60	m ³ /h
200x100	0,015	81,00	m ³ /h	108,00	m ³ /h	135,00	m ³ /h	162,00	m ³ /h	216,00	m ³ /h	270,00	m ³ /h	324,00	m ³ /h	378,00	m ³ /h
250x100	0,019	102,60	m ³ /h	136,80	m ³ /h	171,00	m ³ /h	205,20	m ³ /h	273,60	m ³ /h	342,00	m ³ /h	410,40	m ³ /h	478,80	m ³ /h
300x100	0,023	124,20	m ³ /h	165,60	m ³ /h	207,00	m ³ /h	248,40	m ³ /h	331,20	m ³ /h	414,00	m ³ /h	496,80	m ³ /h	579,60	m ³ /h
400x100	0,031	167,40	m ³ /h	223,20	m ³ /h	279,00	m ³ /h	334,80	m ³ /h	446,40	m ³ /h	558,00	m ³ /h	669,60	m ³ /h	781,20	m ³ /h
450x100	0,035	189,00	m ³ /h	252,00	m ³ /h	315,00	m ³ /h	378,00	m ³ /h	504,00	m ³ /h	630,00	m ³ /h	756,00	m ³ /h	882,00	m ³ /h
500x100	0,038	205,20	m ³ /h	273,60	m ³ /h	342,00	m ³ /h	410,40	m ³ /h	547,20	m ³ /h	684,00	m ³ /h	820,80	m ³ /h	957,60	m ³ /h
600x100	0,046	248,40	m ³ /h	331,20	m ³ /h	414,00	m ³ /h	496,80	m ³ /h	662,40	m ³ /h	828,00	m ³ /h	993,60	m ³ /h	1159,20	m ³ /h
700x100	0,054	291,60	m ³ /h	388,80	m ³ /h	486,00	m ³ /h	583,20	m ³ /h	777,60	m ³ /h	972,00	m ³ /h	1166,40	m ³ /h	1360,80	m ³ /h
800x100	0,061	329,40	m ³ /h	439,20	m ³ /h	549,00	m ³ /h	658,80	m ³ /h	878,40	m ³ /h	1098,00	m ³ /h	1317,60	m ³ /h	1537,20	m ³ /h
1000x100	0,077	415,80	m ³ /h	554,40	m ³ /h	693,00	m ³ /h	831,60	m ³ /h	1108,80	m ³ /h	1386,00	m ³ /h	1663,20	m ³ /h	1940,40	m ³ /h
200x150	0,023	124,20	m ³ /h	165,60	m ³ /h	207,00	m ³ /h	248,40	m ³ /h	331,20	m ³ /h	414,00	m ³ /h	496,80	m ³ /h	579,60	m ³ /h
250x150	0,029	156,60	m ³ /h	208,80	m ³ /h	261,00	m ³ /h	313,20	m ³ /h	417,60	m ³ /h	522,00	m ³ /h	626,40	m ³ /h	730,80	m ³ /h
300x150	0,035	189,00	m ³ /h	252,00	m ³ /h	315,00	m ³ /h	378,00	m ³ /h	504,00	m ³ /h	630,00	m ³ /h	756,00	m ³ /h	882,00	m ³ /h
400x150	0,046	248,40	m ³ /h	331,20	m ³ /h	414,00	m ³ /h	496,80	m ³ /h	662,40	m ³ /h	828,00	m ³ /h	993,60	m ³ /h	1159,20	m ³ /h
450x150	0,052	280,80	m ³ /h	374,40	m ³ /h	468,00	m ³ /h	561,60	m ³ /h	748,80	m ³ /h	936,00	m ³ /h	1123,20	m ³ /h	1310,40	m ³ /h
500x150	0,058	313,20	m ³ /h	417,60	m ³ /h	522,00	m ³ /h	626,40	m ³ /h	835,20	m ³ /h	1044,00	m ³ /h	1252,80	m ³ /h	1461,60	m ³ /h
600x150	0,069	372,60	m ³ /h	496,80	m ³ /h	621,00	m ³ /h	745,20	m ³ /h	993,60	m ³ /h	1242,00	m ³ /h	1490,40	m ³ /h	1738,80	m ³ /h
700x150	0,081	437,40	m ³ /h	583,20	m ³ /h	729,00	m ³ /h	874,80	m ³ /h	1166,40	m ³ /h	1458,00	m ³ /h	1749,60	m ³ /h	2041,20	m ³ /h
800x150	0,092	496,80	m ³ /h	662,40	m ³ /h	828,00	m ³ /h	993,60	m ³ /h	1324,80	m ³ /h	1656,00	m ³ /h	1987,20	m ³ /h	2318,40	m ³ /h
1000x150	0,115	621,00	m ³ /h	828,00	m ³ /h	1035,00	m ³ /h	1242,00	m ³ /h	1656,00	m ³ /h	2070,00	m ³ /h	2484,00	m ³ /h	2898,00	m ³ /h
200x200	0,031	167,40	m ³ /h	223,20	m ³ /h	279,00	m ³ /h	334,80	m ³ /h	446,40	m ³ /h	558,00	m ³ /h	669,60	m ³ /h	781,20	m ³ /h
250x200	0,038	205,20	m ³ /h	273,60	m ³ /h	342,00	m ³ /h	410,40	m ³ /h	547,20	m ³ /h	684,00	m ³ /h	820,80	m ³ /h	957,60	m ³ /h
300x200	0,046	248,40	m ³ /h	331,20	m ³ /h	414,00	m ³ /h	496,80	m ³ /h	662,40	m ³ /h	828,00	m ³ /h	993,60	m ³ /h	1159,20	m ³ /h
400x200	0,061	329,40	m ³ /h	439,20	m ³ /h	549,00	m ³ /h	658,80	m ³ /h	878,40	m ³ /h	1098,00	m ³ /h	1317,60	m ³ /h	1537,20	m ³ /h
450x200	0,069	372,60	m ³ /h	496,80	m ³ /h	621,00	m ³ /h	745,20	m ³ /h	993,60	m ³ /h	1242,00	m ³ /h	1490,40	m ³ /h	1738,80	m ³ /h
500x200	0,077	415,80	m ³ /h	554,40	m ³ /h	693,00	m ³ /h	831,60	m ³ /h	1108,80	m ³ /h	1386,00	m ³ /h	1663,20	m ³ /h	1940,40	m ³ /h
600x200	0,092	496,80	m ³ /h	662,40	m ³ /h	828,00	m ³ /h	993,60	m ³ /h	1324,80	m ³ /h	1656,00	m ³ /h	1987,20	m ³ /h	2318,40	m ³ /h
700x200	0,107	577,80	m ³ /h	770,40	m ³ /h	963,00	m ³ /h	1155,60	m ³ /h	1540,80	m ³ /h	1926,00	m ³ /h	2311,20	m ³ /h	2696,40	m ³ /h
800x200	0,123	664,20	m ³ /h	885,60	m ³ /h	1107,00	m ³ /h	1328,40	m ³ /h	1771,20	m ³ /h	2214,00	m ³ /h	2656,80	m ³ /h	3099,60	m ³ /h
1000x200	0,153	826,20	m ³ /h	1101,60	m ³ /h	1377,00	m ³ /h	1652,40	m ³ /h	2203,20	m ³ /h	2754,00	m ³ /h	3304,80	m ³ /h	3855,60	m ³ /h
1000x250	0,192	1036,80	m ³ /h	1382,40	m ³ /h	1728,00	m ³ /h	2073,60	m ³ /h	2764,80	m ³ /h	3456,00	m ³ /h	4147,20	m ³ /h	4838,40	m ³ /h
1000x300	0,230	1242,00	m ³ /h	1656,00	m ³ /h	2070,00	m ³ /h	2484,00	m ³ /h	3312,00	m ³ /h	4140,00	m ³ /h	4968,00	m ³ /h	5796,00	m ³ /h
1000x400	0,307	1657,80	m ³ /h	2210,40	m ³ /h	2763,00	m ³ /h	3315,60	m ³ /h	4420,80	m ³ /h	5526,00	m ³ /h	6631,20	m ³ /h	7736,40	m ³ /h

LM1 Effective Area Ak(m2)

H / W	200	250	300	400	450	500	600	700	800	1000	1200	1500
75	0,010	0,013	0,015	0,020	0,023	0,025	0,030	0,035	0,040	0,050	0,060	0,075
100	0,013	0,017	0,020	0,027	0,030	0,033	0,040	0,047	0,053	0,067	0,080	0,100
150	0,020	0,025	0,030	0,040	0,045	0,050	0,060	0,070	0,080	0,100	0,120	0,150
200	0,027	0,033	0,040	0,053	0,060	0,067	0,080	0,093	0,107	0,133	0,160	0,200
250	0,033	0,042	0,050	0,067	0,075	0,083	0,100	0,117	0,133	0,167	0,200	0,250
300	0,040	0,050	0,060	0,080	0,090	0,100	0,120	0,140	0,160	0,200	0,240	0,300
400	0,053	0,067	0,080	0,107	0,120	0,133	0,160	0,187	0,213	0,267	0,320	0,400
450	0,060	0,075	0,090	0,120	0,135	0,150	0,180	0,210	0,240	0,300	0,360	0,450
500	0,067	0,083	0,100	0,133	0,150	0,167	0,200	0,233	0,267	0,333	0,400	0,500
600	0,080	0,100	0,120	0,160	0,180	0,200	0,240	0,280	0,320	0,400	0,480	0,600

Table-1

LM2 Effective Area Ak(m2)

H / W	200	250	300	400	450	500	600	700	800	1000	1200	1500
75	0,012	0,014	0,017	0,023	0,026	0,029	0,035	0,040	0,046	0,058	0,069	0,086
100	0,015	0,019	0,023	0,031	0,035	0,038	0,046	0,054	0,061	0,077	0,092	0,115
150	0,023	0,029	0,035	0,046	0,052	0,058	0,069	0,081	0,092	0,115	0,138	0,173
200	0,031	0,038	0,046	0,061	0,069	0,077	0,092	0,107	0,123	0,153	0,184	0,230
250	0,038	0,048	0,058	0,077	0,086	0,096	0,115	0,134	0,153	0,192	0,230	0,288
300	0,046	0,058	0,069	0,092	0,104	0,115	0,138	0,161	0,184	0,230	0,276	0,345
400	0,061	0,077	0,092	0,123	0,138	0,153	0,184	0,215	0,245	0,307	0,368	0,460
450	0,069	0,086	0,104	0,138	0,155	0,173	0,207	0,242	0,276	0,345	0,414	0,518
500	0,077	0,096	0,115	0,153	0,173	0,192	0,230	0,268	0,307	0,383	0,460	0,575
600	0,092	0,115	0,138	0,184	0,207	0,230	0,276	0,322	0,368	0,460	0,552	0,690

Table-2

LM3 Effective Area Ak(m2)

H / W	200	250	300	400	450	500	600	700	800	1000	1200	1500
75	0,010	0,013	0,015	0,020	0,023	0,025	0,030	0,035	0,040	0,050	0,060	0,075
100	0,013	0,017	0,020	0,027	0,030	0,033	0,040	0,047	0,053	0,067	0,080	0,100
150	0,020	0,025	0,030	0,040	0,045	0,050	0,060	0,070	0,080	0,100	0,120	0,150
200	0,027	0,033	0,040	0,053	0,060	0,067	0,080	0,093	0,107	0,133	0,160	0,200
250	0,033	0,042	0,050	0,067	0,075	0,083	0,100	0,117	0,133	0,167	0,200	0,250
300	0,040	0,050	0,060	0,080	0,090	0,100	0,120	0,140	0,160	0,200	0,240	0,300
400	0,053	0,067	0,080	0,107	0,120	0,133	0,160	0,187	0,213	0,267	0,320	0,400
450	0,060	0,075	0,090	0,120	0,135	0,150	0,180	0,210	0,240	0,300	0,360	0,450
500	0,067	0,083	0,100	0,133	0,150	0,167	0,200	0,233	0,267	0,333	0,400	0,500
600	0,080	0,100	0,120	0,160	0,180	0,200	0,240	0,280	0,320	0,400	0,480	0,600

Table-3

SUPPLY LM1 SELECTION DIAGRAM

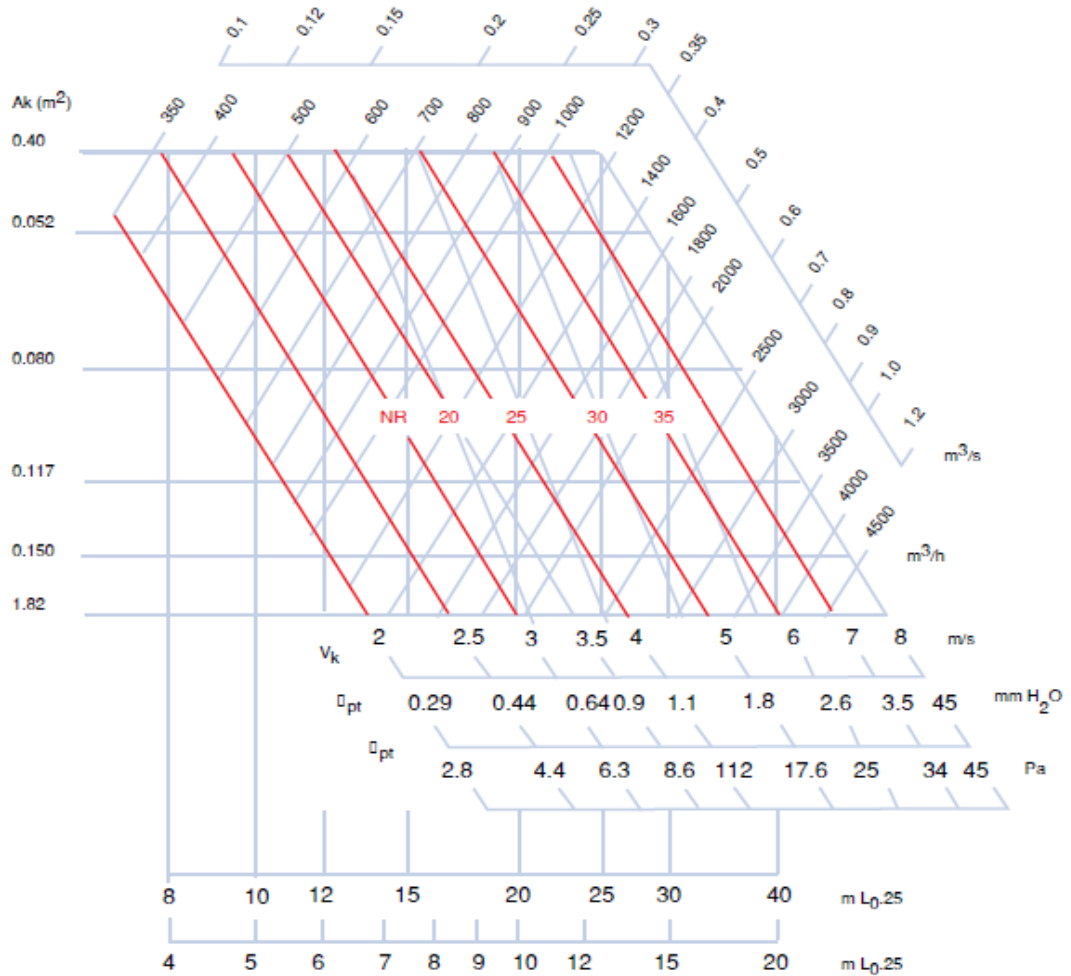
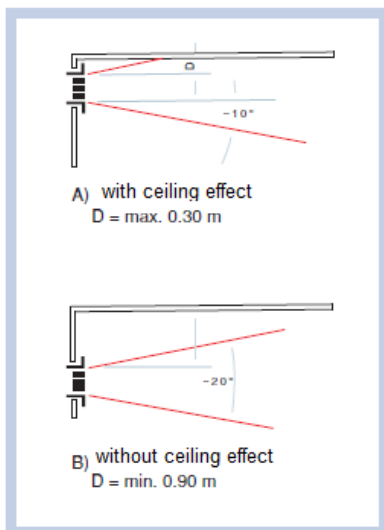

Diagram-1

CEILING EFFECT



Vt(m/s) Correction Table

Vt (m/s)		0.25	0.375	0.5	0.825
Table-4	Lt A	x 1	x 0.67	x 0.5	x 0.4
	B	x0.7	x0.47	x 0.35	x0.28

Volume and Pressure Loss Table

Damper Position	100 % açık	50 % açık	25 % açık
Pt X 1.00	Pt X 1.00	Pt X 2.25	Pt X5.90
LW + 0	LW + 0	LW +10	LW +20

Table-5

Grille Length for Correction Table

B (m)	1	1.5	2	2.5	3	4	5	6	8	10
Lt (m)	X 1	X 10.5			X 1.1				X 1.15	
Lw (NR)	0	+ 2	+ 3	+ 4	+ 5	+ 6	+ 7	+ 8	+ 9	+10

Table-6

RETURN LM1 SELECTION DIAGRAM

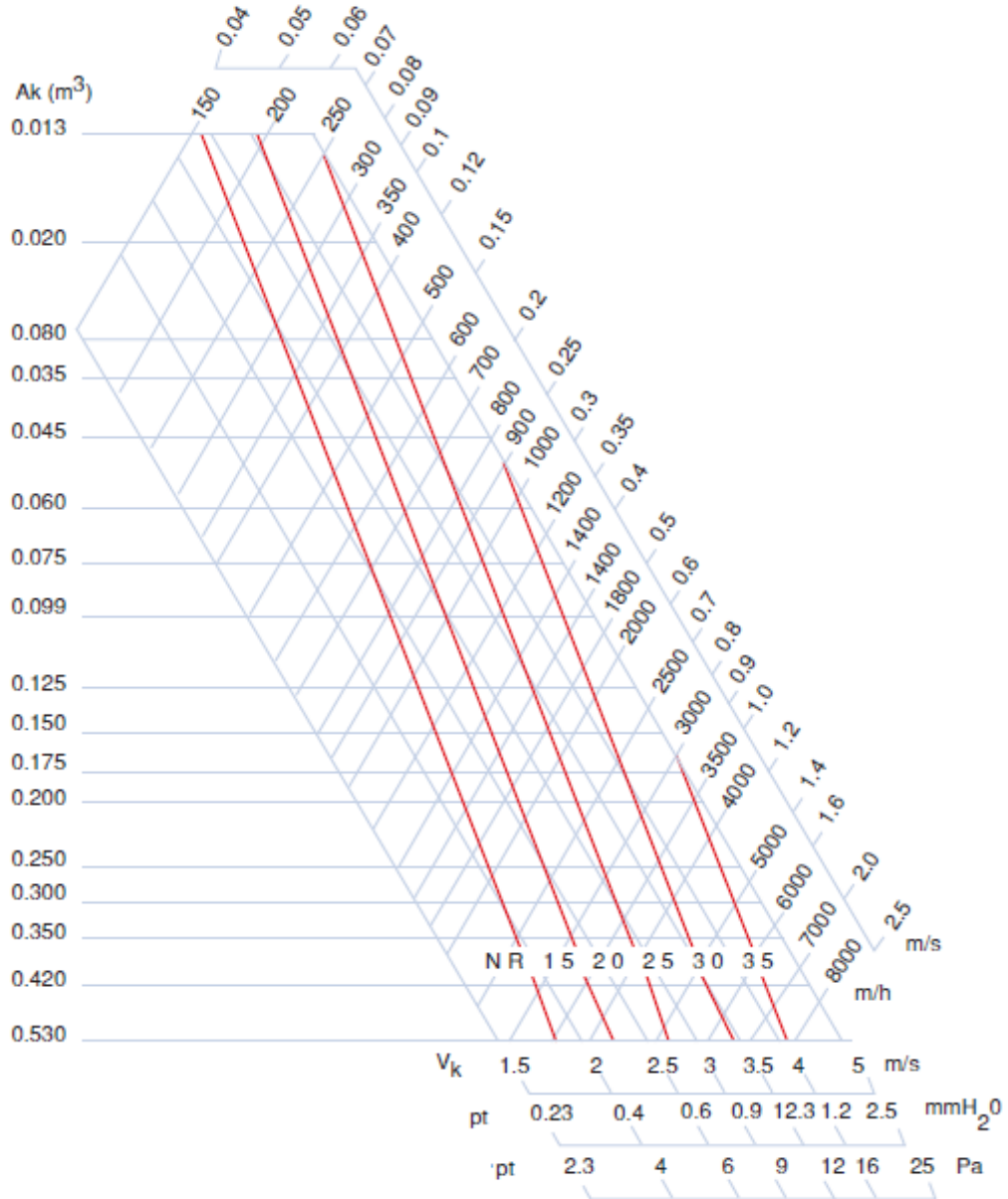

Diagram-2

Volume and Pressure Loss Table

Damper Position	100 % açık	50 % açık	25 % açık
Pt X 1.00	Pt X 1.00	Pt X 2.25	Pt X 5.90
LW + 0	LW + 0	LW +10	LW +20

Table -7

SUPPLY LM2 SELECTION DIAGRAM

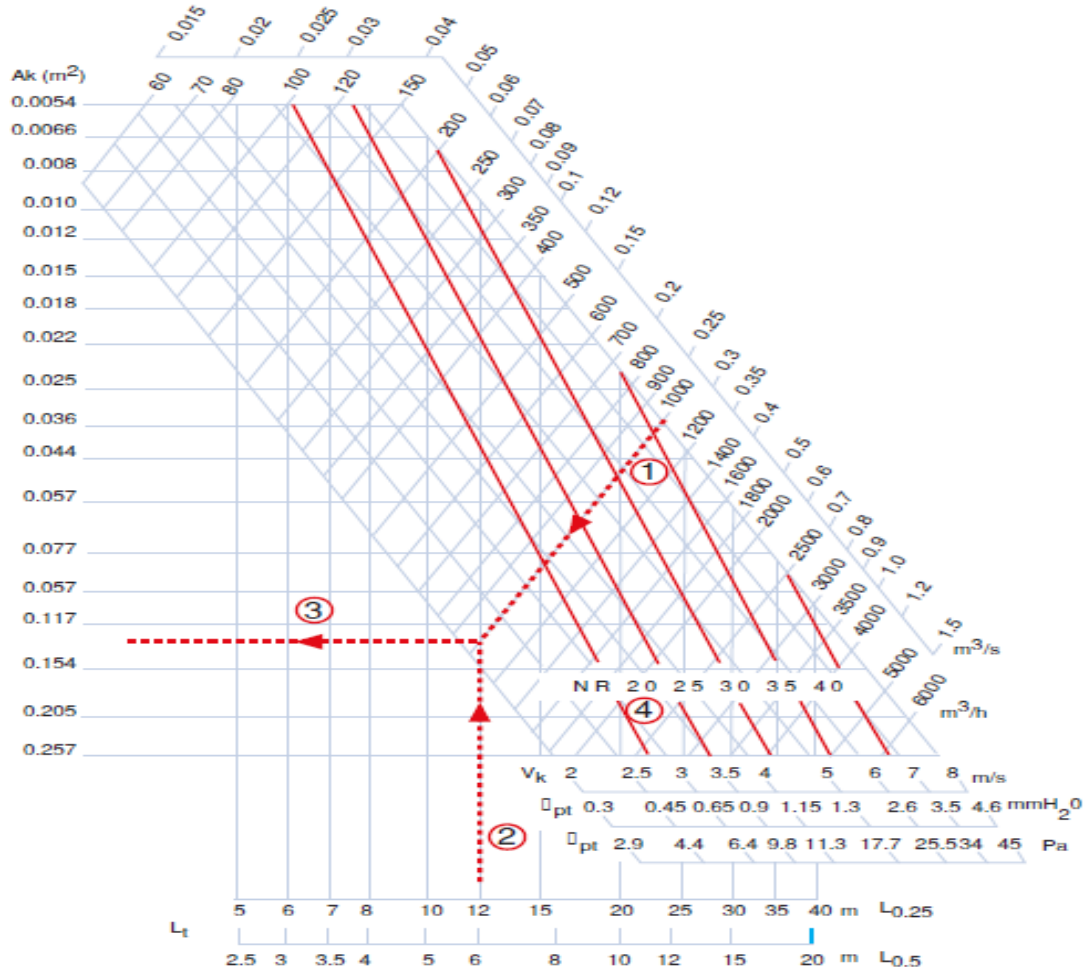
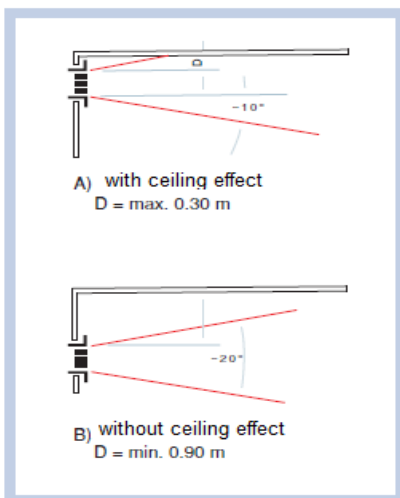

Diagram-3

CEILING EFFECT



V_t (m/s) Correction Table

V_t (m/s)		0.25	0.375	0.5	0.825
Table-8	Lt A	x 1	x 0.67	x 0.5	x 0.4
	Lt B	x0.7	x0.47	x 0.35	x0.28

Volume and Pressure Loss Table

Damper Position		100 % açık	50 % açık	25 % açık
Table-9	Pt X 1.00	Pt X 1.00	Pt X 2.25	Pt X5.90
	LW + 0	LW + 0	LW +10	LW +20

Grille Length for Correction Table

B (m)	1	1.5	2	2.5	3	4	5	6	8	10
Table-10	Lt (m)	X 1	X 10.5	X 1.1				X 1.15		
Lw (NR)	0	+ 2	+ 3	+ 4	+ 5	+ 6	+ 7	+ 8	+ 9	+10

RETURN LM2 SELECTION DIAGRAM

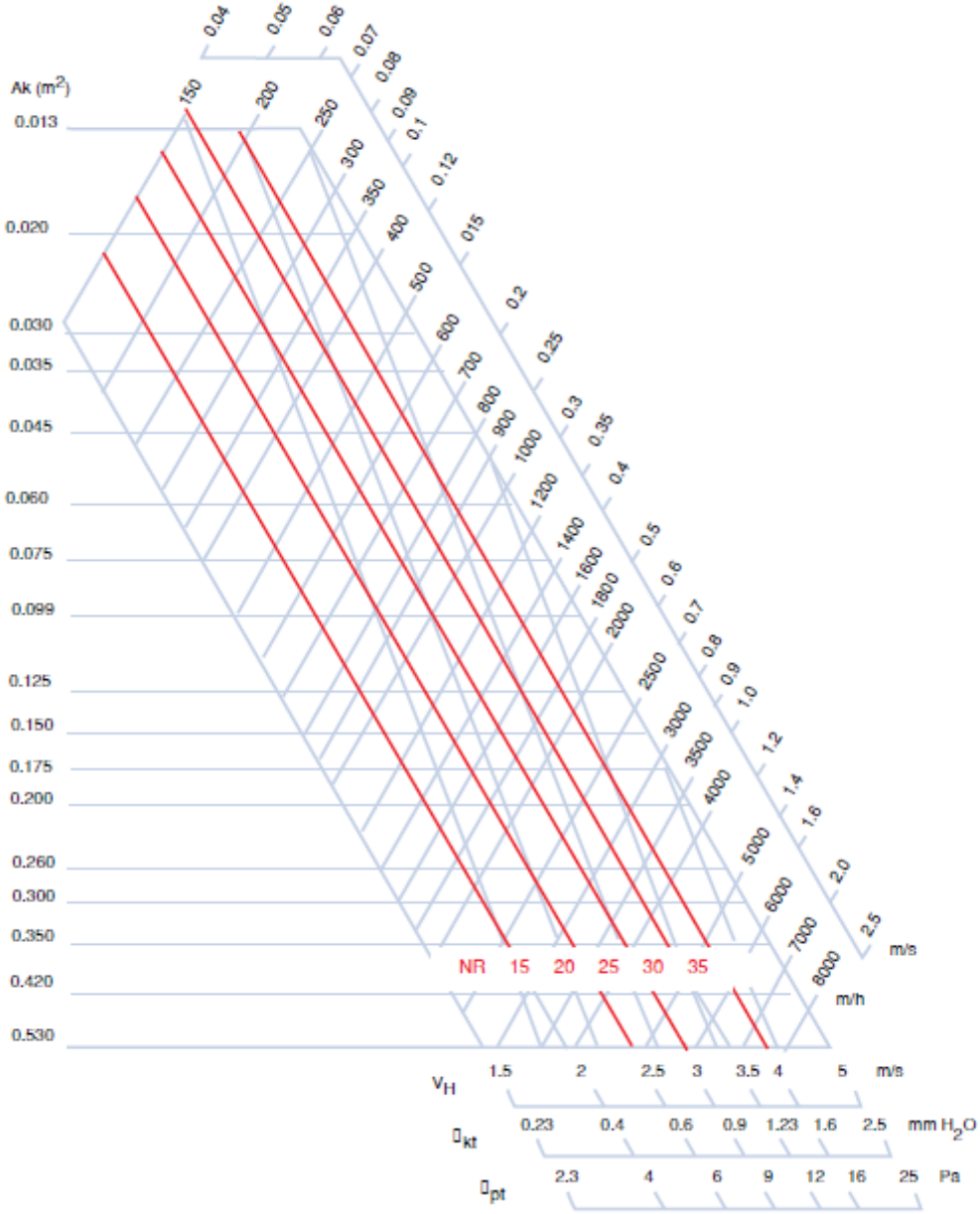

Diagram-4

Volume and Pressure Loss Table

Damper Pozition	100 % açık	50 % açık	25 % açık
Pt X 1.00	Pt X 1.00	Pt X 2.25	Pt X5.90
LW + 0	LW + 0	LW +10	LW +20

Table-11

SUPPLY LM3 SELECTION DIAGRAM

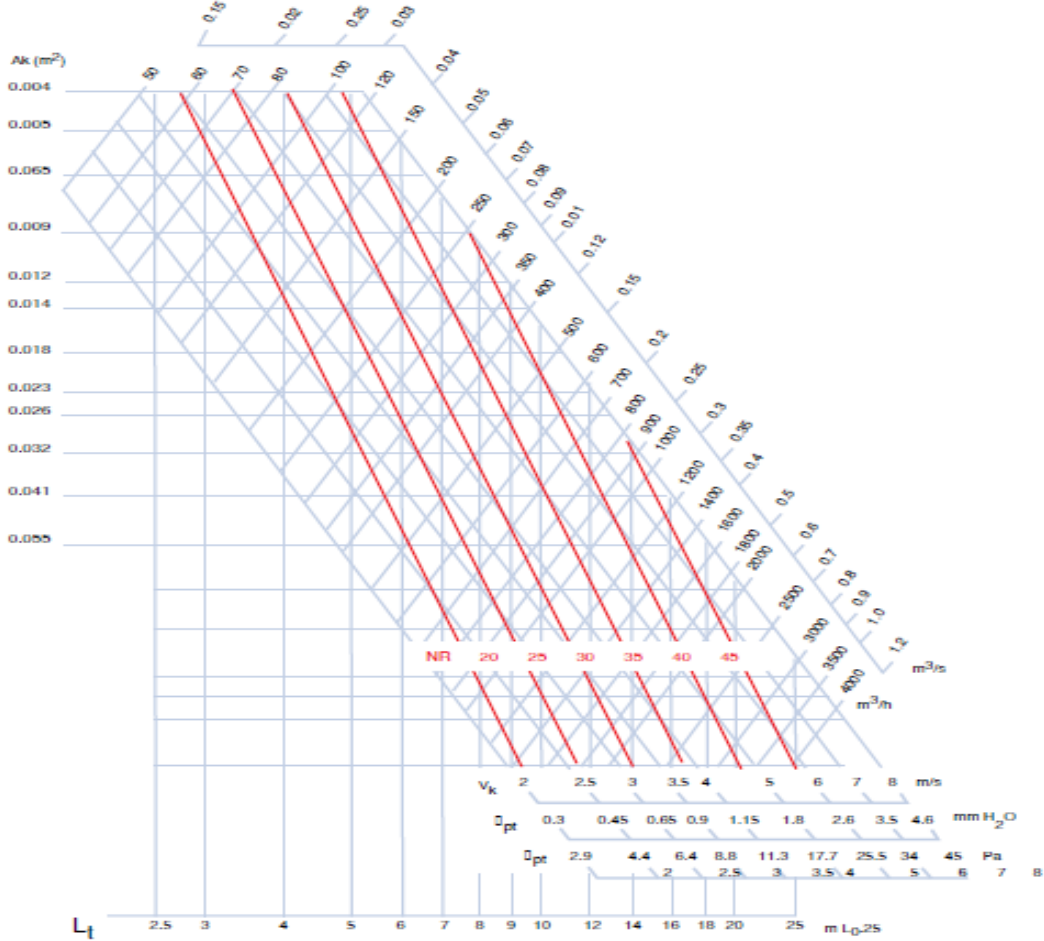
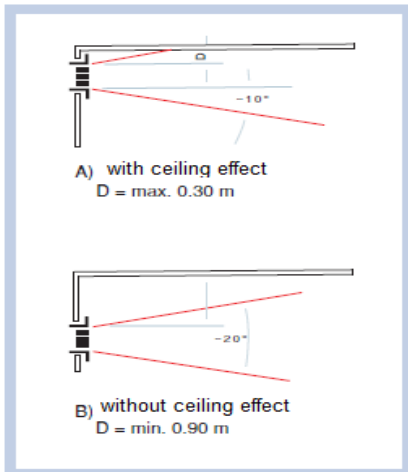

Diagram-5

CEILING EFFECT



V_t (m/s) Correction Table

		0.25	0.375	0.5	0.825
Table-12	Vt (m/s)	0.25	0.375	0.5	0.825
	Lt	A	x 1	x 0.67	x 0.5
		B	x0.7	x0.47	x 0.35
					x0.28

Volume and Pressure Loss Table

Damper Position	100 % açık	50 % açık	25 % açık
Table-13	Pt X 1.00	Pt X 1.00	Pt X 2.25
	LW + 0	LW + 0	LW + 10
			Pt X 5.90
			LW + 20

Grille Length for Correction Table

B (m)	1	1.5	2	2.5	3	4	5	6	8	10
Table-14	Lt (m)	X 1	X 10.5	X 1.1				X 1.15		
	Lw (NR)	0	+ 2	+ 3	+ 4	+ 5	+ 6	+ 7	+ 8	+ 9
									+ 10	

RETURN LM3 SELECTION DIAGRAM

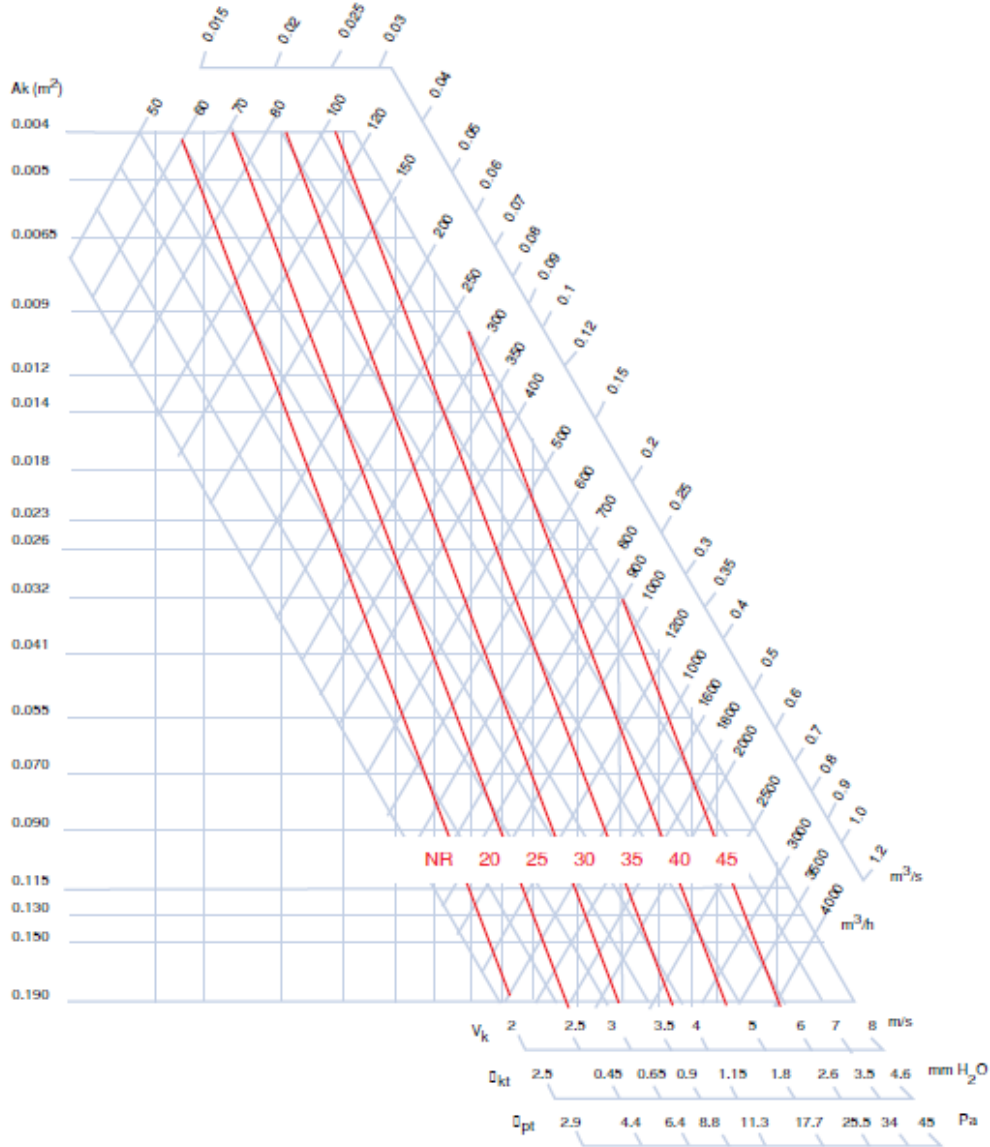

Diagram-6

Volume and Pressure Loss Table

Damper Pozition	100 % açık	50 % açık	25 % açık
Pt X 1.00	Pt X 1.00	Pt X 2.25	Pt X 5.90
LW + 0	LW + 0	LW +10	LW +20

Table-15

Sample Grille Selection:

LM2 Blade, $Q_v = 1000 \text{ m}^3/\text{h}$, Room Length: 6 m, $V_t : 0,5\text{m/s}$

Result :

Table 9 for $L_t 0,5= 12\text{m}$, Diagram 3 for ; $A_k : 0,123\text{m}^2$ (3) , $V_k: 2,4 \text{ m/s}$ (4) Selection

LM1, LM2, LM3 AIR FALL SELECTION DIAGRAM

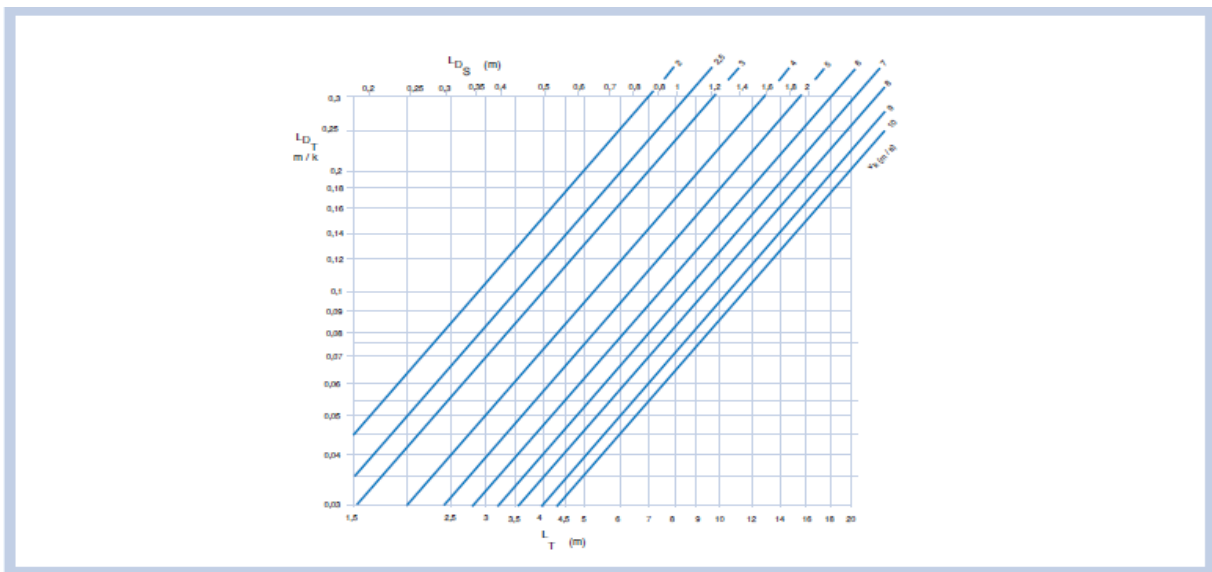
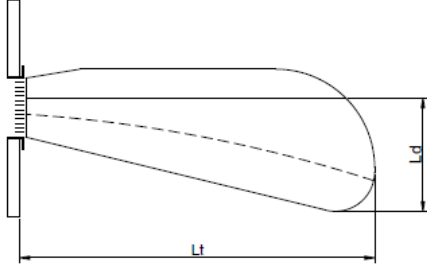

Diagram-7

AIR FALL



Description :

The total air drop is the vertical distance between the air drop center and the lowest point to the air drop Vt (m / s). Total air loss consists of two components.

$$Ld = Lds + Ldt$$

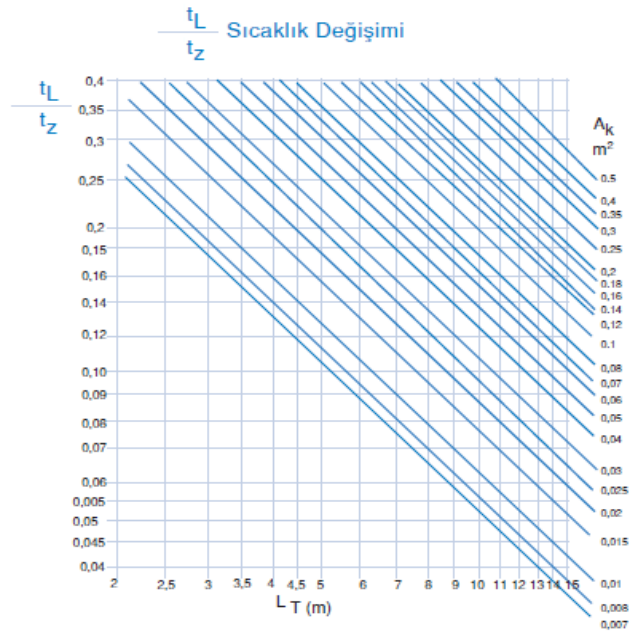
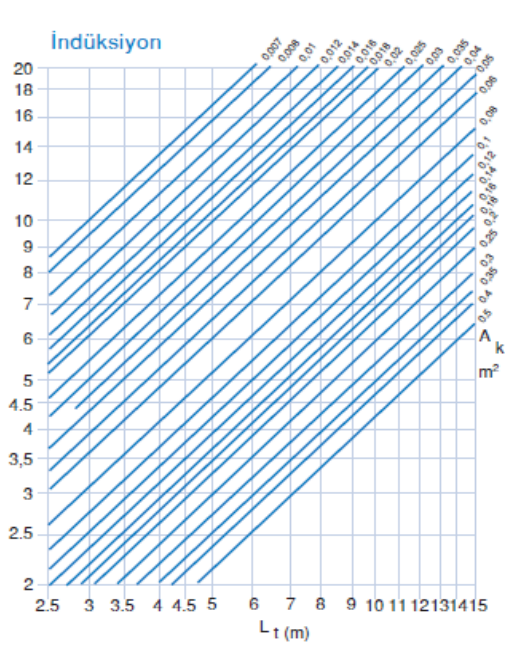

Diagram-8

T_L / T_z : Temperature Change

T_L (K) : Maximum temperature difference between room temperature and air temperature

T_z (K) : Maximum temperature difference between room temperature and distributor air temperature

I : induction

LM1, LM2, LM3 MOUNTING DETAILS

1. Screw Mounting Details

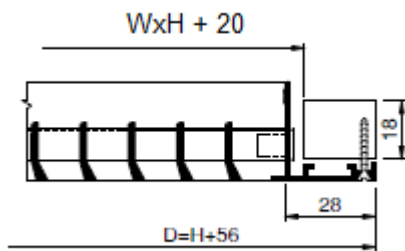

2. Clips Mounting Details

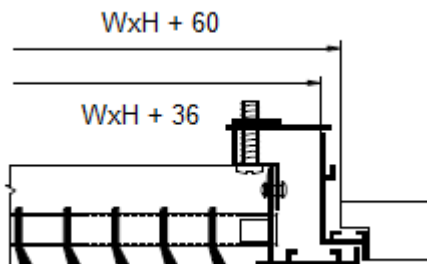

3. Spring Mounting Details

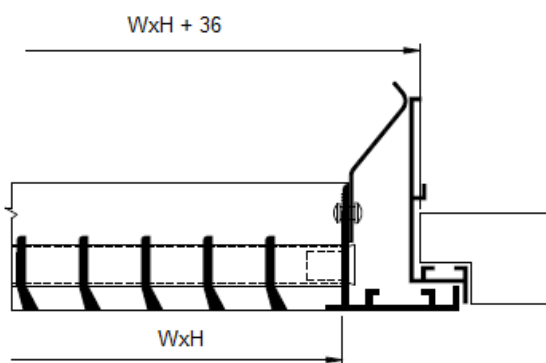

CREW MOUNTING HOLE PALACEMENT

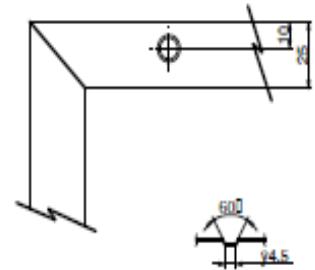
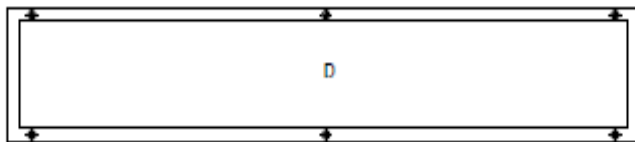
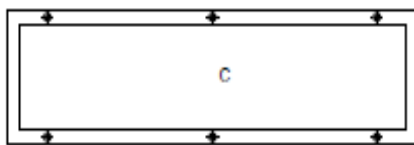
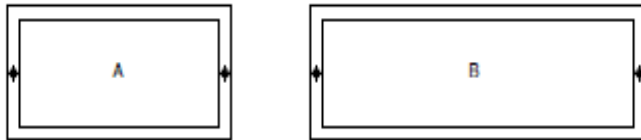

W /L	200	250	300	400	500	600	800	1000	1200	1500
100	A	A	A	A	A	C	C	C	D	D
150		A	A	A	A	C	C	C	D	D
200				B	B	C	C	C	D	D
300					B	C	C	C	D	D

LM1, LM2, LM3 LINEAR GRILLES PLENUM BOX MOUNTING DETAILS

1 - TOP ENTRY PLENUM BOX MOUNTING DETAILS

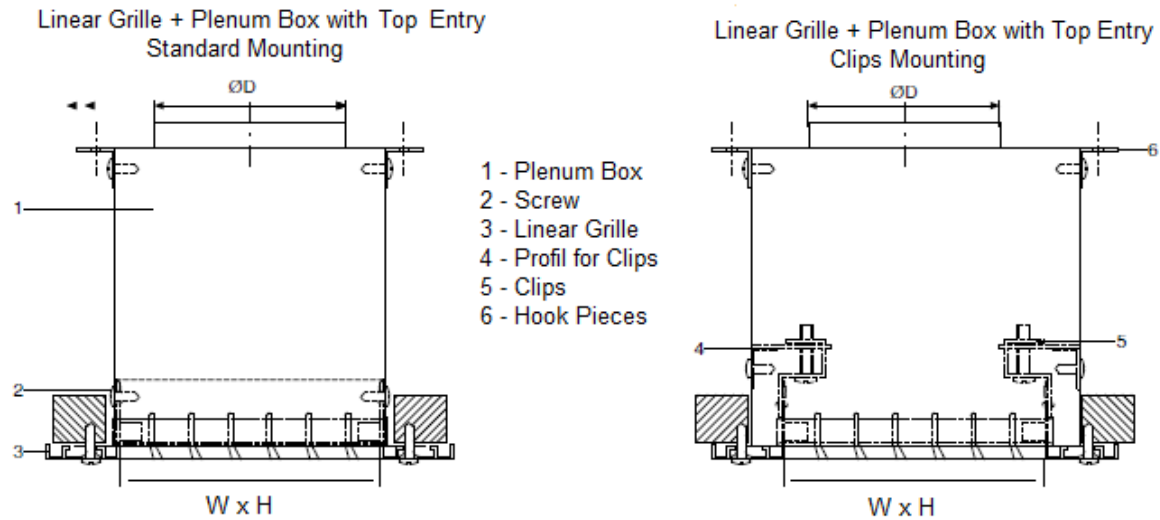

2 - SID ENTRY PLENUM BOX MOUNTING DETAILS

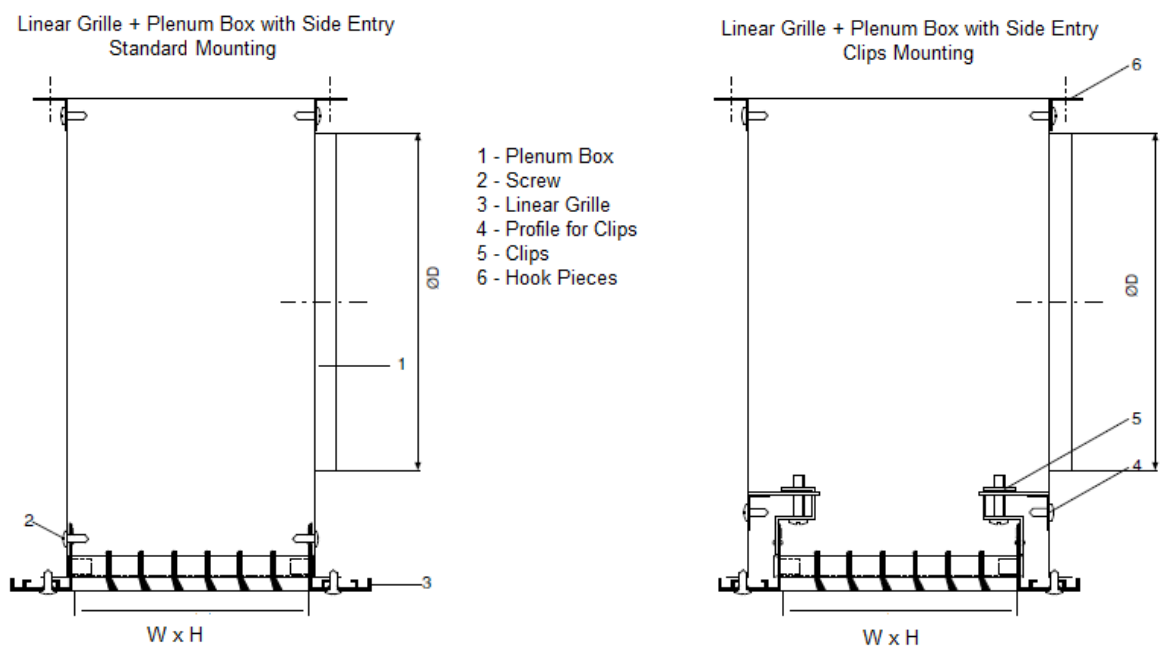

K-VENTIL

LINEAR GRILLES

ORDER CODE

LM	1	28	PKD	RAL9010	VD	W 300X200
LM1 Blade: 1 LM2 Blade: 2 LM3 Blade: 3						W: Neck Size C: Frame Size
17mm Frame : 17mm 22mm Frame : 22mm 28mm Frame : 28mm 32mm Frame : 32mm						00: without Mounting VD: Screw Mounting KL: Clips Mounting ST: Spring Mounting
000: without Damper ZKD: Opposite Blade Damper PKD: Parallel Blade Damper FL : With Filter						00: without coating EL: Anodic Aluminium RAL----: Powder Coated RAL